

ALUMINIJUMSKE OGRADE ZA DVORIŠTA FENCE SYSTEM PROFILES



065/ 360-61-63



ALUMINIJUMSKE OGRADE ZA DVORIŠTA
FENCE SYSTEM PROFILES



European Standart (EN)





ALUMINAKS

— ALUMINIUM & ACCESSORIES —



MESA POL®

Korkuluk Sistemleri

ALUMINIJUMSKE OGRADE ZA DVORIŠTA

Sav materijal je sertifikovan standardima građevinskih proizvoda , a postupci ugradnje tehničkim zahtevima.

-Ramovi 60x60 i 60x40 su debljine 2 mm.

-Tarabice 80x20mm i Tarabice 100x20mm su 1.2mm debljine.

-Plastifikacija se vrši isključivo austrijskom "TIGER Coatings" bojom.

-Koristimo jedne od najkvalitetnijih brava (STUBLINA), cilindre (ABUS) i nemačke kvake odličnog kvaliteta.

-Šarke za kapije nisu fiksne, već su napravljene tako da naše klijenti imaju pristup štelovanju.

Pri svakoj promeni vremena, bilo leto ili zima, svaki metal se širi ili skuplja pa tako i aluminijum.

Sa našim šarkama imate pristup da SAMI sa par okretanja ključem kapiju vratite u prvobitni položaj i nemate problem sa zatvranjem.

*Aluminijumske ograde koje izrađujemo ne zahtevaju dodatno održavanje i dovoljno je samo brisanje krpom.

Aluminijumske ograde imaju izuzetno dug vek trajanja, otporne su na sve klimatske uslove, sunce, vlagu i koroziju.

*Ograde izrađujemo po vašim željama od najpostojanijeg aluminijuma, koji odoleva svim vremenskim uslovima.

Ugrađujemo isključivo štelujuće šarke vrhunskog kvaliteta.

*Motori za klizne ili dvokrilne kapije, elektronski prihvatnik za pešačke kapije, rukohvat (inox ili silver) koji se seče i bira po želji kupca.

Fiksna ručka (kugla). Dekorativni elementi od drveta.

Modeli:

-VERONA

-PALERMO

-MODENA

-ROMA



VERONA



PALERMO





MODENA



ROMA

ALUMINIJUMSKE OGRADE ZA STEPENIŠTA I TERASE

Aluminijumska ograda na sebi ima posebnu vrstu zaštite, takozvanu "eloksažu", pa se zato i kaže eloksirani aluminijum. Ovo važi za sve modele inox i silver. Ta zaštita se meri MIKRONIMA a kompanija od koje direktno uvozimo materijal garantuje da materijal na sebi sadrži 13-15 MIKRONA te da je za vremenske prilike u Srbiji predviđeno da jedan mikron zaštite traje 3 do 5 godina. Minimalan rok trajanja aluminijumske ograde je 30 godina, bez obzira na to da li je ograda izložena kiši, suncu ili vetru.

-U ponudi imamo širok izbor staklenih ograde u kombinaciji sa aluminijumskom konstrukcijom na koju se staklo montira pa sve do modernih staklenih ograde koje se pričvršćuju za podnu, aluminijumsku šinu obloženu aluminijumskim maskama. Staklo koje koristimo je Laminirano (pamplex) staklo ili kaljeno staklo. Debljine stakla zavise od modela ograde, a najčešće se koriste 8mm-10mm-12mm-14mm-16mm-20mm. Boju stakla bira klijent a u ponudi su transparentna (providna) stakla i tonirana stakla (sivo, braon, mlečno, zeleno, plavo).

-Aluminijumske ograde koje izrađujemo ne zahtevaju dodatno održavanje. Dovoljno je samo brisanje krpom i ograda je kao nova! Aluminijumske ograde imaju izuzetno dug vek trajanja, otporne su na sve klimatske uslove, sunce, vlagu i koroziju. Nema rđe, nema farbanja i nema apsolutnog nikakvog održavanja.

MODELI:

- VENECIJA
- PARIZ
- MOSKVA
- MILANO
- LONDON
- FIRENCA
- CHICAGO
- BERLIN
- ATINA



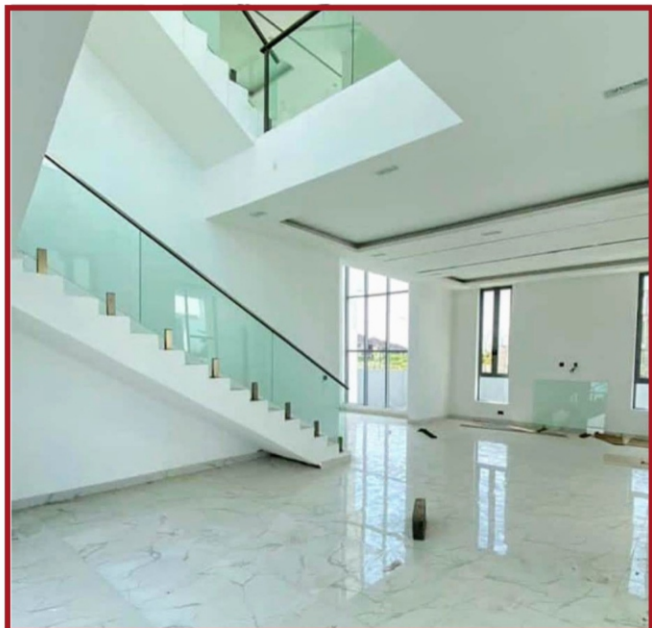

VENECIJA



PARIZ

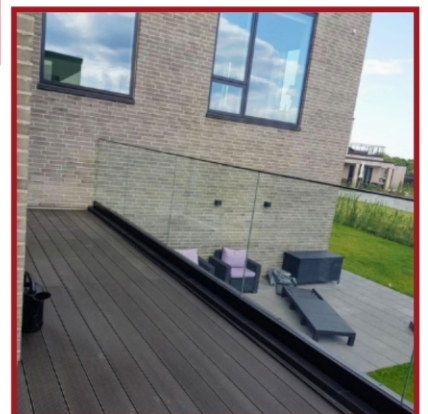

MOSKVA

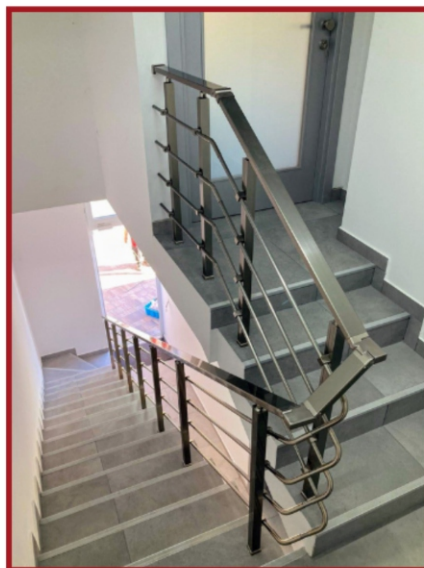
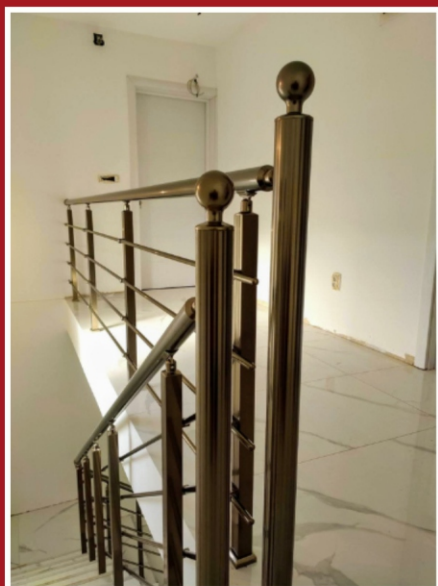

MILANO

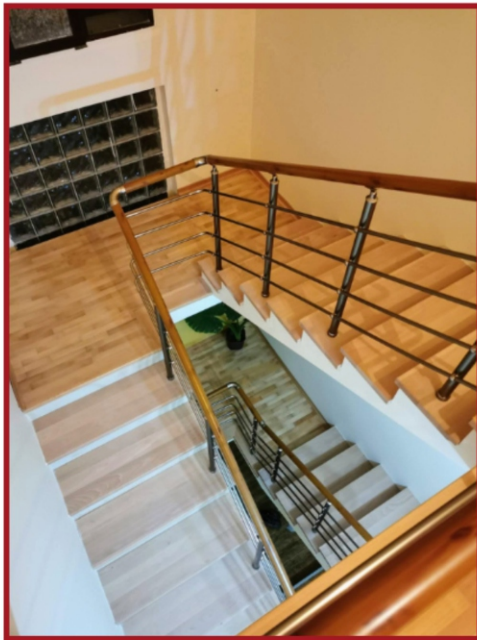

LONDON

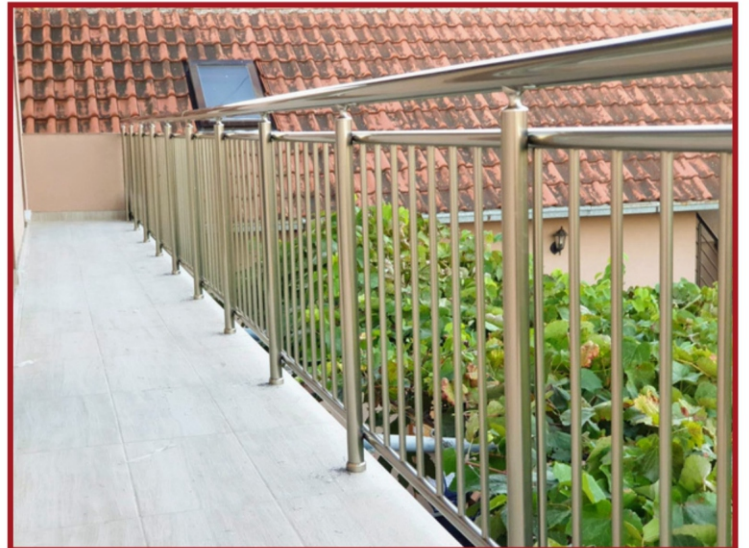

FIRENCA



CHICAGO



BERLIN



ATINA



ALUMINIJUMSKA VRATA

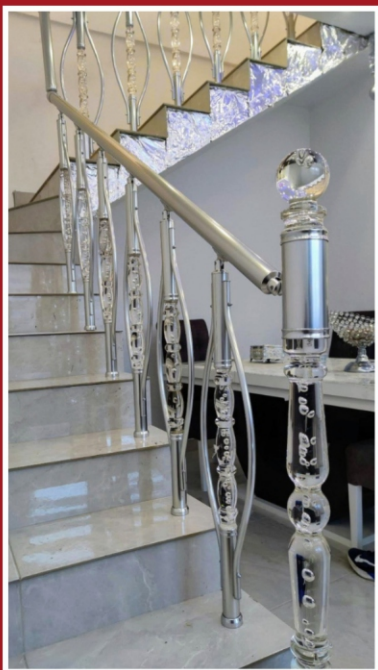

**ALUMINIJUMSKE OGRADE SA
DEKORATIVNIM ELEMENTIMA
OD PLEKSIGLASA**



ALUMINIJUMSKE BIOKLIMATSKE PERGOLE

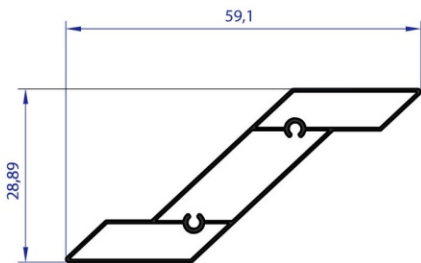

AB 98415
WEIGHT 0.890 Kg/m

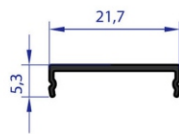

AB 98338
WEIGHT 0.076 Kg/m

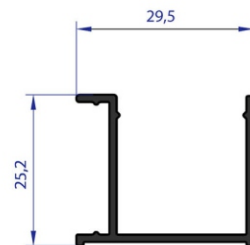

AB 98339
WEIGHT 0.272 Kg/m

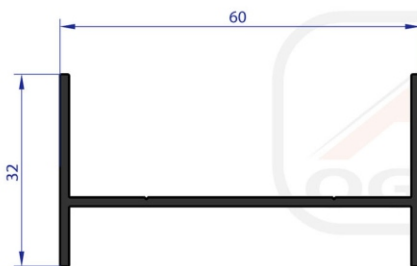

AB 98340
WEIGHT 0.492 Kg/m

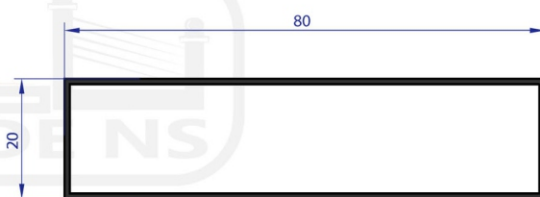

AB 97842
WEIGHT 0.479 Kg/m

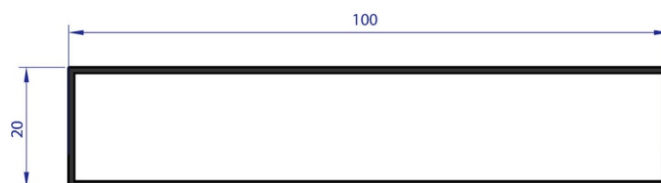

AB 92702
WEIGHT 0.640 Kg/m

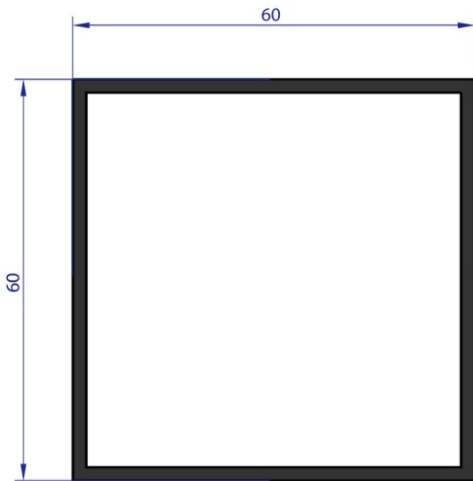

AB 91519
WEIGHT 1.257 Kg/m

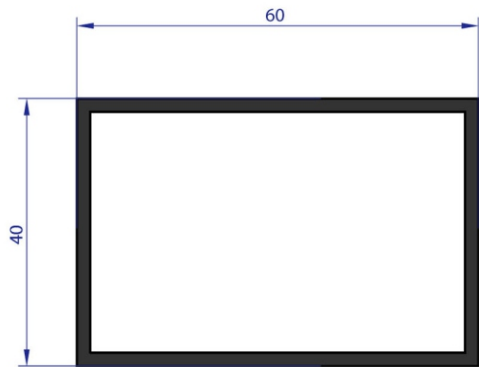

AB 91515
WEIGHT 1.040 Kg/m

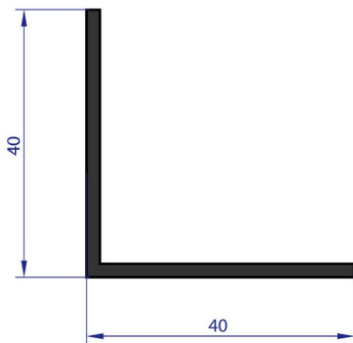

AB 91568
WEIGHT 0.437 Kg/m

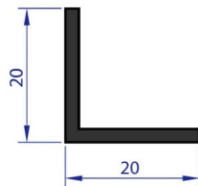

AB 91585
WEIGHT 0.206 Kg/m

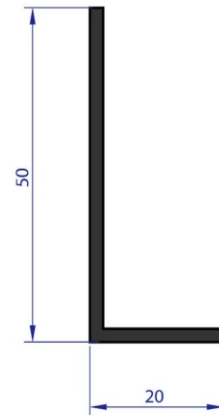

AB 96965
WEIGHT 0.368 Kg/m

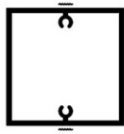

ÖLÇEK / SCALE 1 / 2

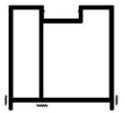
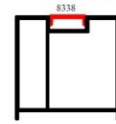
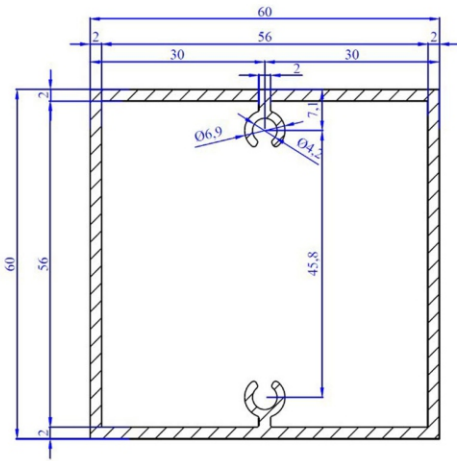

ÖLÇEK / SCALE 1 / 2

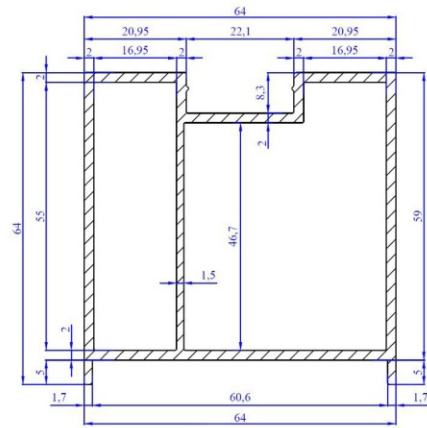

REV-2



ÖLÇEK / SCALE 1 / 1

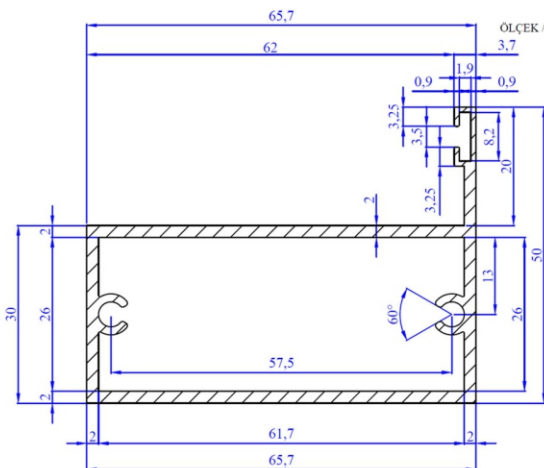



Audio interfoni

Audio interfoni se obično koriste za komunikaciju između ulaza u objekte, stanove ili dvorišta (pozivna tabla) i unutrašnjosti objekta (slušalica) u koji se odobrava pristup postavljanjem električne i mehaničke interfone brave na ulaznim vratima. Na slušalici se nalazi taster za slanje signala za otvaranje vrata, i opciono, taster se može postaviti sa unutrašnje strane ulaznih vrata. Pozivna tabla interfona može da sadrži jedan ili više pozivnih tastara, kao i mogućnost komunikacije između korisnika (slušalica) u zavisnosti od broja korisnika u objektu i prema zahtevima naručioca.



Video interfoni

Video interfoni se koriste za audio vizuelnu komunikaciju između ulaza u objekte, stanove ili dvorišta (pozivna tabla sa kamerom) i unutrašnjosti objekta (slušalica sa monitorom) u koji se odobrava pristup postavljanjem električne i mehaničke interfone brave na ulaznim vratima. Kombinovanjem audio interfona i kamere na ulazu u objekat (ili više kamera), moguće je distribuirati video signal kroz antenski ili kablovski sistem što omogućava korisnicima da prate sliku na TV prijemnicima.





Motori za klizne kapije - ACER "LIFE"

Motor sa centralom - elektronika sa prijemnikom
Dve dvokanalne daljinske komande - za veći broj korisnika dodatno se isporučuju daljinske komande
Antena sa kablom RG58 - za veći domet daljinskih komandi
Sigurnosne foto ćelije - prekida rad motora ako je snop između foto ćelija prekinut
Signalna lampa - svojim radom obaveštava da je sistem u radu
Graničnici za zupčastu letvu - prekida rad motora do željene tačke
Zupčasta letva - isporučuje se posebno u zavisnosti od dužine kapije



Motori za krilne kapije - OPTIMO "LIFE"

Centrala - elektronika sa prijemnikom
Dva motora za krilnu kapiju - OPTIMO 2,3, ili 5 u zavisnosti od potreba
Dve dvokanalne daljinske komande - za veći broj korisnika dodatno se isporučuju daljinske komande
Antena sa kablom RG58 - za veći domet daljinskih komandi
Sigurnosne foto ćelije - prekida rad motora ako je snop između foto ćelija prekinut
Signalna lampa - svojim radom obaveštava da je sistem u radu
Metalni nosači motora - montiraju se na noseći stub kapije i kapiju



Motori za krilne kapije - ARMOR "LIFE"

Centrala - elektronika sa prijemnikom
Dva motora za krilnu kapiju - ARMOR
Dve dvokanalne daljinske komande - za veći broj korisnika dodatno se isporučuju daljinske komande
Antena sa kablom RG58 - za veći domet daljinskih komandi
Sigurnosne foto ćelije - prekida rad motora ako je snop između foto ćelija prekinut
Signalna lampa - svojim radom obaveštava da je sistem u radu
Metalni nosači motora - montiraju se na noseći stub kapije i kapiju







ALU OGRADE NS

Nikole Tesle 27, Temerin - SERBIA

contact@alu-ogradens.rs

tel: 060/ 360-61-64

<https://alu-ogradens.rs> - contact@alu-ogradens.rs